

Rubber Fab Technologies Group's
**The Perfect Surface
Hygienic Seal
System**

Featuring Torque-Rite®
and the Perfect
Surface Hygienic Seal

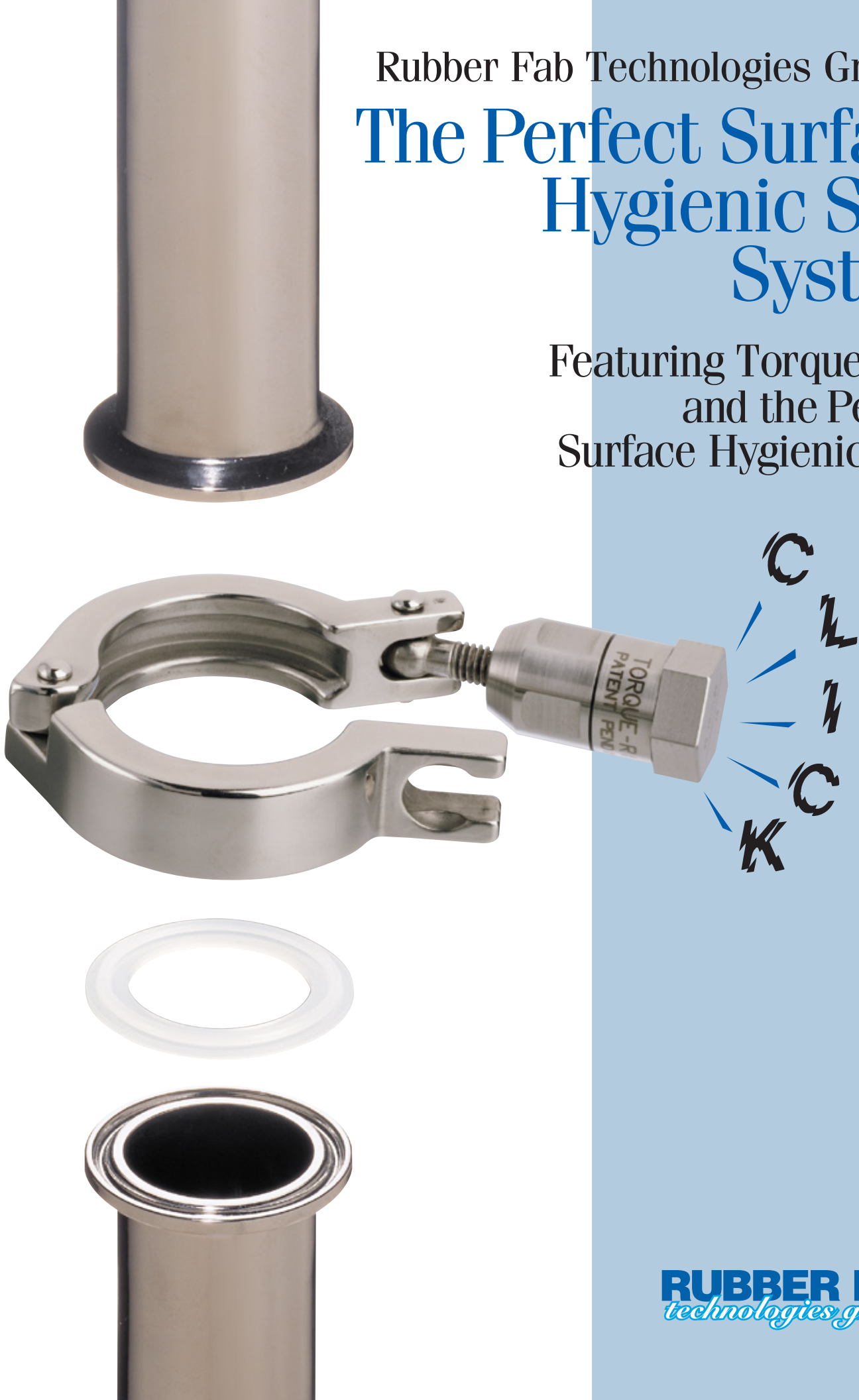

Torque-Rite®

Presenting Rubber Fab's **Perfect Surface Hygienic Seal System**. The perfect union of Torque-Rite and the family of Perfect Surface Hygienic Seals.



Torque-Rite allows you to control compression and expansion while maintaining constant inch/pounds force insuring a Perfect Surface I.D. when used with a **Perfect Surface Hygienic Seal**. Torque-Rite eliminates the problems associated with over - or under-tightening a seal which can lead to an unsanitary system.

Compression control is easy!

When tightened, the Torque-Rite's self-limiting internal mechanism will make an audible “**click**” signaling the user they have reached proper inch/pounds force. If further tightening is attempted, there will be more “**clicks**” but no additional application of force on the hygienic seal (if emergency conditions arise, the Torque-Rite has a built-in manual **override feature**).

Problems with over-tightening or under-tightening a hygienic seal:

Over-tightening can tear or damage a seal and can also cause a damming effect inside the pipeline. A torn or extruded seal can hold soil and bacteria. Under-tightening leaves an undesirable concave area at the seal allowing soil and bacteria to become entrapped. Both conditions should be avoided in a sanitary system.

Maintaining a “Perfect Surface” Sanitary System.

By maintaining a constant force on a Perfect Surface Hygienic Seal with the Torque-Rite, seal I.D. is maintained lowering bacteria count and enhancing product integrity.

A Perfect Surface sanitary system is assured.

The Perfect Surface System

$$\frac{\text{Torque-Rite}}{\text{Perfect Surface Hygienic Seal}} = \frac{\text{Compression Control}}{\text{Expansion Control}} = \text{Perfect Surface}$$

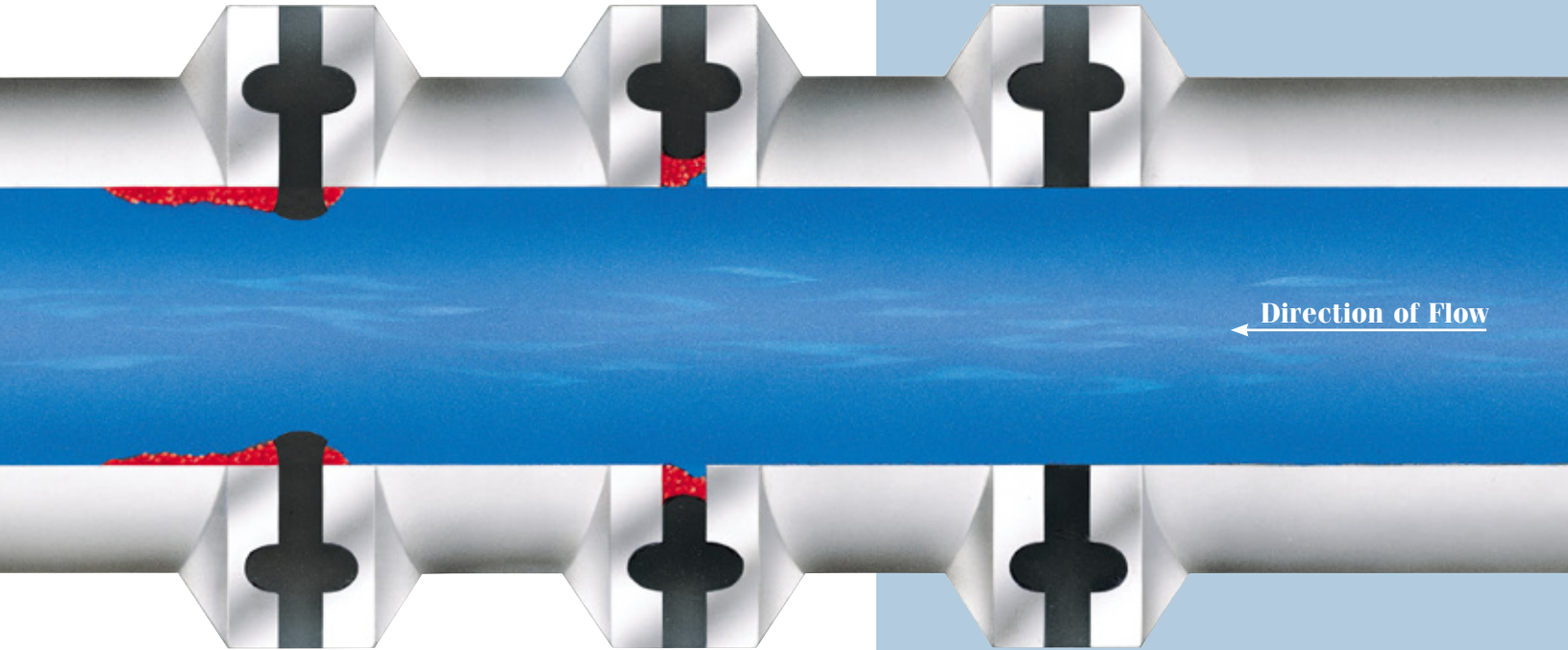

DAMMING:
An over-tightened hygienic seal extrudes into the pipe, prevents draining, and allows deposits to build up behind the gasket.

UNDER-TIGHTENING:
May allow leakage. Can form concave surfaces at the product side of the hygienic seal affecting free drainage and cleaning.

PERFECT SURFACE HYGIENIC SEAL SYSTEM:
Torque-Rite and Perfect Surface Hygienic Seal eliminates the concerns associated with over- and under-tightening a hygienic seal. Insures that seal I.D. matches pipe I.D.

Torque-Rite Specifications

Material: 440C Stainless Steel
 Hardness: 48 Rockwell
 Overall Height: 1.670"
 Driving Hex: .875 (7/8")
 Body Diameter: .875"
 Override Flats: .8125 (13/16")
 Lot Traceable

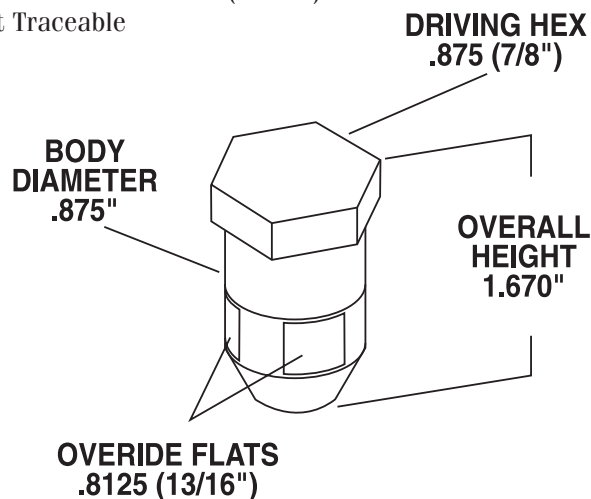

Torque-Rite is available in two models.

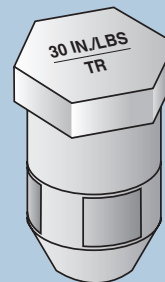

Model
TR-30

Perfect Surface Hygienic Seal Material
 Buna
 Silicone
 FKM
 Fluoroelastomer
 EPDM
 Tuf-Flex®

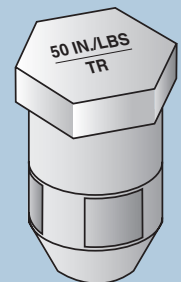

Model
TR-50

Perfect Surface Hygienic Seal Material
 PTFE
 Tuf-Steel®
 PTFE Envelope

Perfect Surface Hygienic Seal Benefits:

- Lower bacteria counts
- Maintains/enhances product integrity
- **Insures that hygienic seal I.D. matches pipe I.D.**
- Passes **US Pharmacopeia Class VI Certification**
- Passes **cytotoxicity criteria**
- Complies with **Title 21 CFR 177.2600**
- Complies with **Title 21 CFR 177.1550**
- Complies with **USDA and 3-A sanitary standards**
- **Conforms to CGMP** (Current Good Manufacturing Practices)
- **Metal Detectable Elastomers available**
- **Animal Derived Ingredient Free**

Torque-Rite® Features:

- An **audible “click”** indicating correct inch/pounds force
- **Maintains constant 30 or 50 inch/pounds force**
- **Manual override feature**
- **Retrofits all sanitary clamps, mini through 6”**
- **Works in rupture disk applications**
- **Works with all Smart Gasket® products** including spore trap, thermocoupler and sampler
- **No torque wrench or special training required**
- **User friendly**

NOTE: All elastomeric hygienic seals require periodic replacement. Seal life is influenced by the seal material, product application, temperature, cleaning procedures, etc. After monitoring seal condition in a process system, a schedule should be developed for periodic replacement of hygienic seals.

© Smart Gasket, Torque-Rite, Tuf-Flex, Tuf-Steel and ADI Free are registered trademarks of Rubber Fab Technologies Group.

Torque-Rite: United States Patent Number 6,082,941.

Rubber Fab Technologies Group's Metal Detectable products are patent pending.



RUBBER FAB

technologies group

Rubber Fab Technologies Group

26 Brookfield Drive • Sparta, NJ 07871

phone: 973-579-2959 • fax: 973-579-7275

www.rubberfab.com

New From Rubber Fab Technologies Group



**Design...Validation...Production
...Quality Assurance**

Improving Product Quality and Consistency.

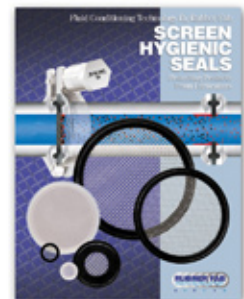

Rubber Fab Technologies Group, a Material Science Company, is a leading innovator of high quality sanitary hygienic seals, hose assemblies, valve, pump and filler machine components in a wide range of high purity elastomer materials. For additional information, contact Rubber Fab at 973-579-2959 or visit us at www.rubberfab.com.

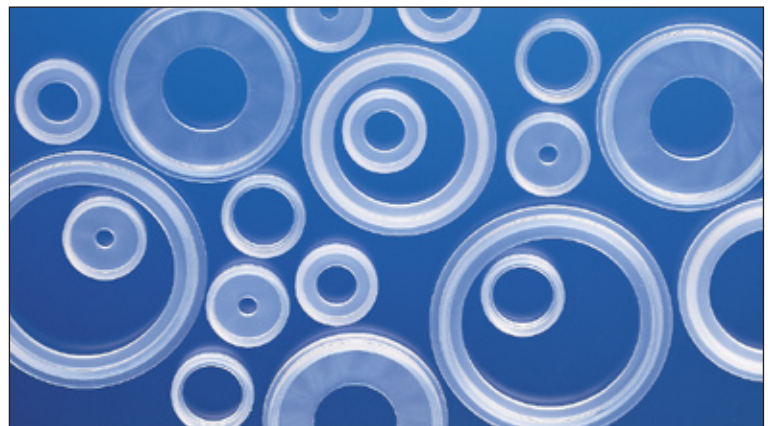

Rubber Fab Technologies Group is a member of:

Distributed by:

