



The safe choice for High Purity applications

Tri-Clover LKB UltraPure automatic or manual butterfly valve

Application

Tri-Clover LKB UltraPure is an automatic or manual operated butterfly valve for on/off duties. The UltraPure execution is designed and documented to meet the demand in industries like BioPharm and Personal Care.

Working principles

Tri-Clover LKB UltraPure is either remote controlled by means of an air-actuator or manually by means of a handle.

The actuator is designed so that an axial movement of a piston is transformed into a 90° rotation of a shaft. The torque of the actuator is increased when the valve disc contacts the seal of the valve.

The handle for manual operation mechanically lock the valve in its open or closed position.

Standard design

Tri-Clover LKB UltraPure consists of two body halves, valve disc, bushings for the disc stem and a seal ring. The valve is assembled by means of screws and nuts.

The air-actuator is made in three standard versions, normally closed (NC), normally open (NO) and air/air activated (A/A).

Two actuator sizes, ø85 mm and ø133 mm, cover all valve sizes and is available in two versions, LKLA and LKLA-T (T for mounting of indication unit on actuator).

The actuator is fitted on to the valve by means of a bracket and screws. The handle for manual operation is fitted on to the valve by means of a cap/block system and a screw.

The handles for the are available in 2 positions, 4 positions, regulating 90° and lockable multi-position.

The valve can be supplied with either welding or clamp connections.

Control Equipment

Control and indication is possible in connection with the remote controlled valve. See Options.

LKLA-T can be fitted with Topunits

Documentation

All valves are delivered with Alfa Laval Q-doc including:

- 3.1 certificate in accordance to EN 10204
- FDA compliance and USP Class VI declaration
- TSE statement
- Surface finish declaration (Ra)
- Manufacturing and quality procedures



Tri-Clover LKB UltraPure

Delivery conditions

- Individually marked with manufactures logo, ID number, pressure rating, material, standard, dimension and surface finish
- Supplied with plastic end caps and individually packed together with the documentation

Distributed by:

Tri-Canada

7033 Telford Way #20, Mississauga, ON L5S 1V4

Tel: 905.677.9000 • Toll Free: 1.800.486.7863

www.tricanada.com

Torque diagrams - Actuator

LKLA ø85 mm:

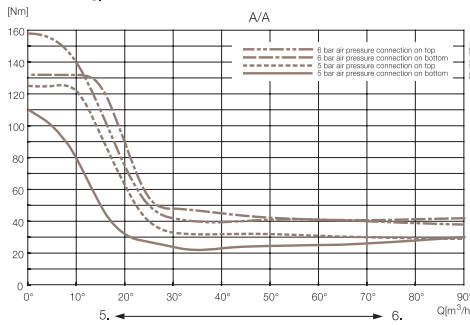
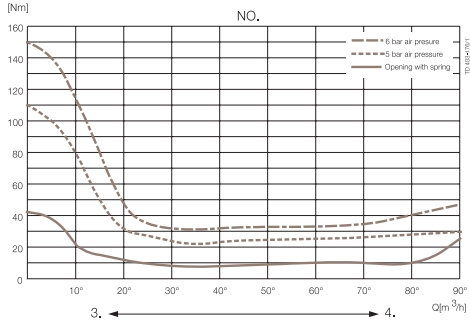
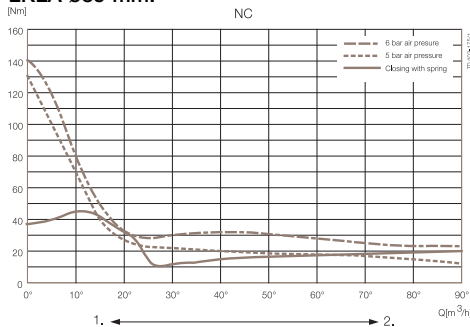

LKLA ø133 mm:

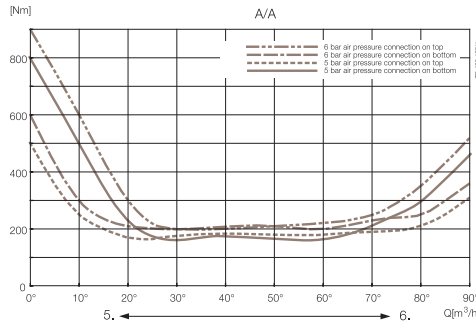
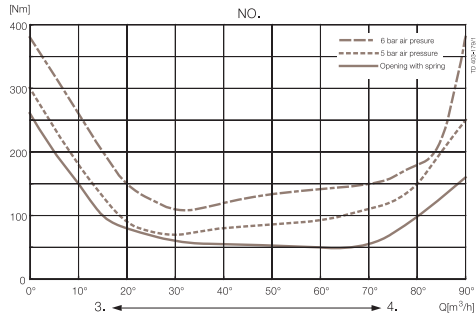
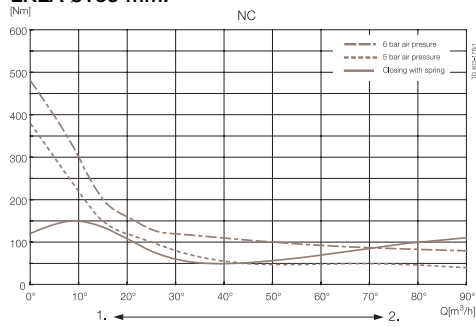

Torque values (for rotating the valve disc in a dry seal ring)

Size			Max. Nm
25 mm	DN25	1"	15
	DN32		15
38 mm	DN40	1½"	15
51 mm	DN50	2"	20
63.5 mm	DN65	2½"	25
76 mm	DN80	3"	30
101.6 mm	DN100	4"	35

Angular motion of actuator:

1. Closing - Spring activated
2. Opening - Air activated
3. Closing - Air activated
4. Opening - Spring activated
5. Closing
6. Opening

Capacity/Pressure drop diagrams

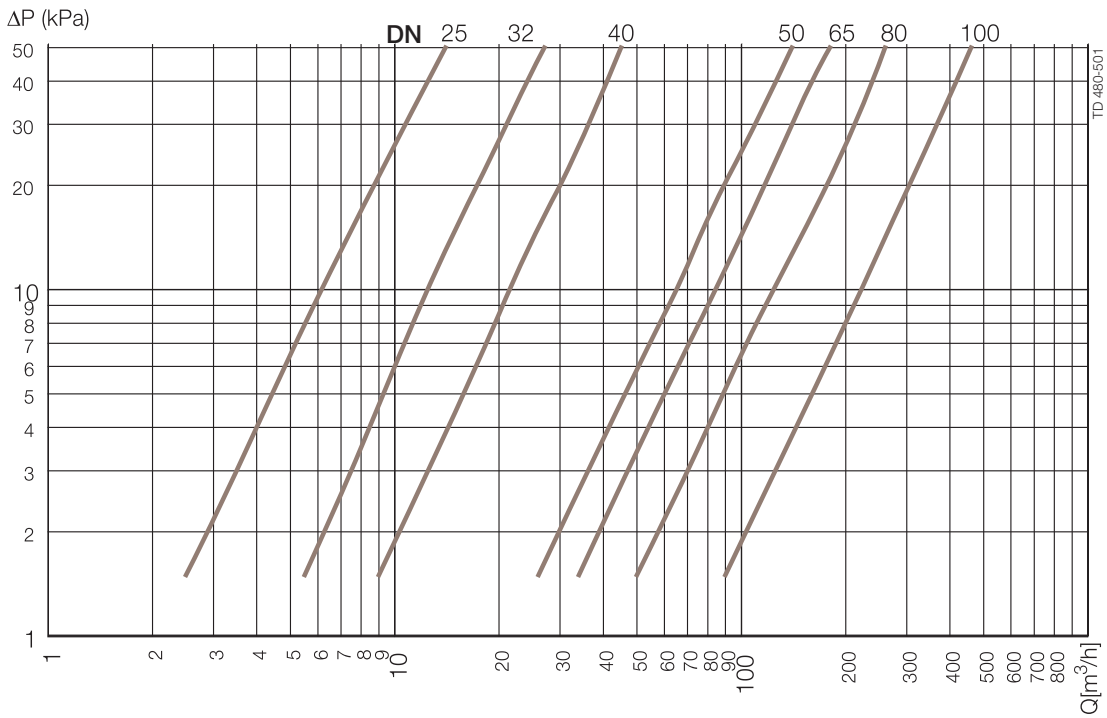
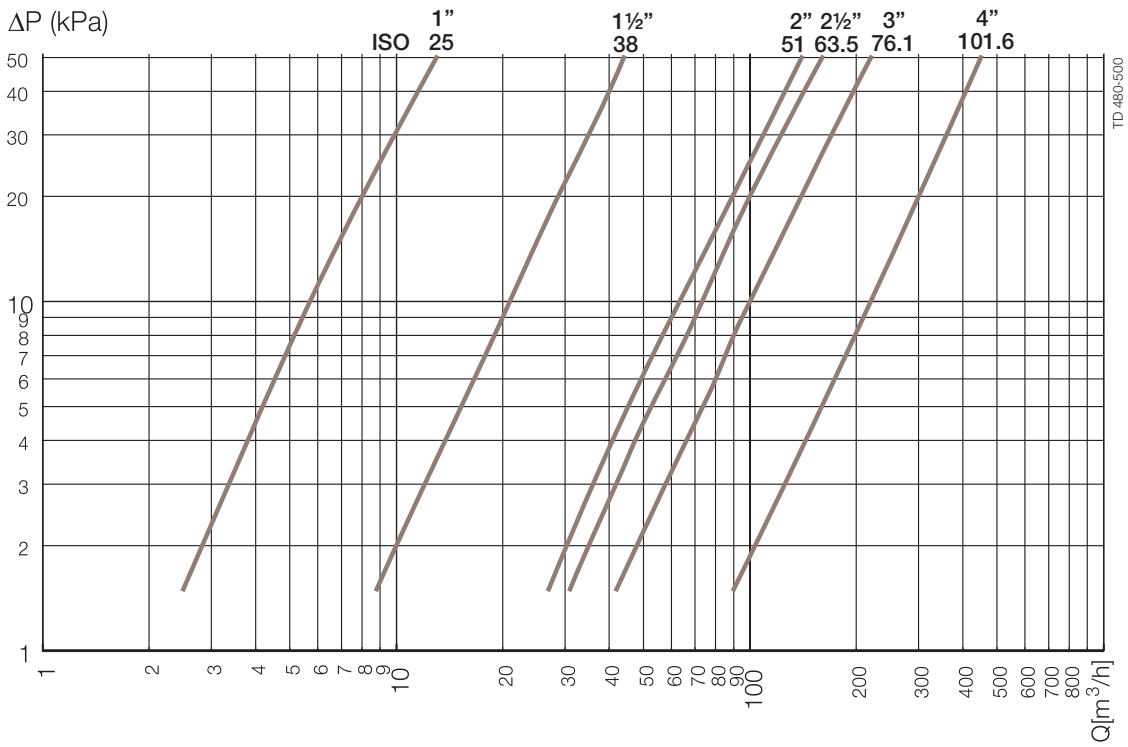

NOTE!

For the diagrams the following applies:

Medium: Water (20°C).

Measurement: In accordance with VDI 2173.

Dimensions

Fig. 1. Dimensions - valve.

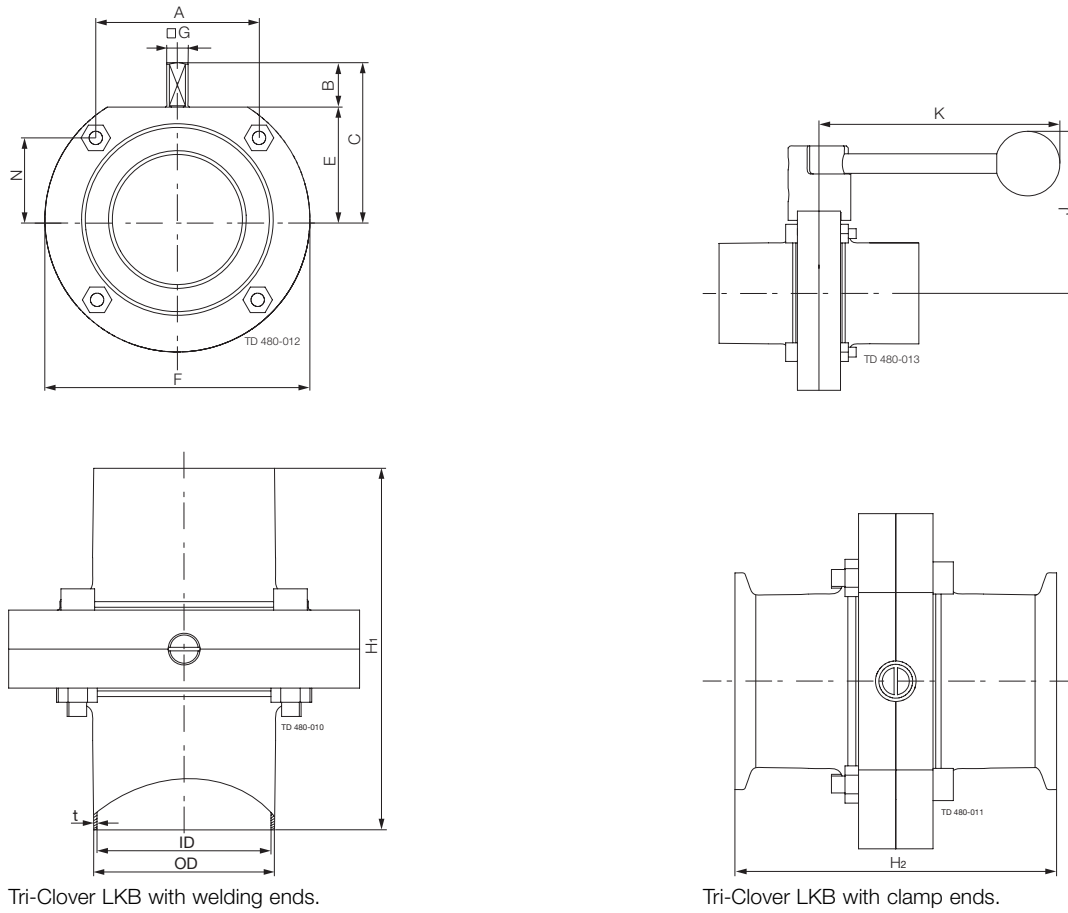
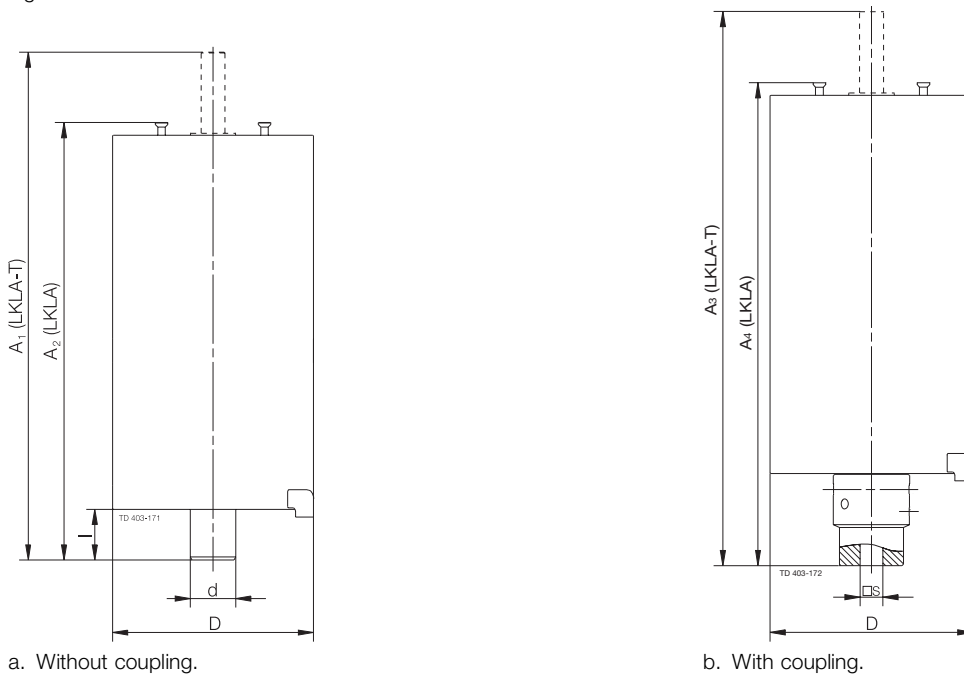

Fig. 2. Dimensions - actuators.



Dimensions (mm)

Tri-Clover LKB UltraPure

Size	25 mm	38 mm	51 mm	63.5 mm	76.1 mm	101.6 mm	DN 25	DN 32	DN 40	DN 50	DN 65	DN 80	DN 100
A	42.00	42.00	61.00	61.00	79.50	106.00	42.00	42.00	42.00	61.00	61.00	79.00	106.00
B	15.50	16.70	16.60	17.50	16.60	16.00	14.70	15.90	16.70	16.60	17.50	16.00	160.00
C	49.00	49.00	58.50	69.50	73.50	93.00	48.00	49.00	54.00	63.00	75.00	79.00	93.00
OD	25.00	38.00	51.00	63.50	76.10	101.60	29.00	35.00	41.00	53.00	70.00	85.00	104.00
ID	22.60	35.60	48.60	60.30	72.90	97.60	26.00	32.00	38.00	50.00	66.00	81.00	100.00
t	1.20	1.20	1.20	1.60	1.60	2.00	1.50	1.50	1.50	1.50	2.00	2.00	2.00
E	32.50	32.50	42.00	52.00	57.00	77.00	33.30	33.30	37.70	46.60	57.30	63.00	77.00
F	78.00	78.00	99.00	117.00	132.00	169.00	79.00	79.00	86.50	105.70	125.00	143.00	169.00
□G	8	8	8	8	10	12	8	8	8	8	10	10	12
H1	127.00	127.00	132.00	134.00	162.00	180.00	127.00	127.00	127.00	132.00	142.00	164.00	180.00
H2	104.20	104.20	109.20	111.20	176.40	194.40	90.00	90.00	90.00	95.00	118.00	120.00	136.00
J	82.00	82.00	92.00	102.00	107.00	127.00	74.00	74.00	78.00	88.00	98.00	104.00	118.00
K	120.00	120.00	120.00	120.00	162.00	162.00	120.00	120.00	120.00	120.00	162.00	162.00	162.00
N	26.50	26.50	30.50	40.50	43.50	53.00	27.30	27.30	31.70	35.10	45.80	49.50	53.00
Weight (kg)	1.2	1.0	1.5	2.1	3.0	4.7	1.2	1.1	1.3	1.8	3.1	3.5	5.1

NOTE! Weights are for valves with welding ends and handles.

Size	1"	1½"	2"	2½"	3"	4"
A	42.00	42.00	61.00	61.00	79.50	106.00
B	15.50	16.70	16.60	17.50	16.60	16.00
C	49.00	49.00	58.50	69.50	73.50	93.00
OD	25.40	38.10	50.80	63.50	76.20	101.60
ID	22.1	34.8	47.5	60.2	72.9	97.38
t	1.65	1.65	1.65	1.65	1.65	2.11
E	32.50	32.50	42.00	52.00	57.00	77.00
F	78.00	78.00	99.00	117.00	132.00	169.00
□G	8	8	8	8	10	12
H1	127.00	127	132.00	134.00	162.00	180.00
H2	104.20	104.20	109.20	111.20	176.40	194.40
J	82.0	82.0	92.00	102.00	107.00	127.00
K	120.00	120.00	120.00	120.00	162.00	162.00
N	26.50	26.50	30.50	40.50	43.50	53.00
Weight (kg)	1.2	1.0	1.5	2.1	3.0	4.7

NOTE! Weights are for valves with welding ends and handles.

Dimensions (mm) - Actuator

LKLA and LKLA-T:

Valve size	25-63.5 mm DN25-50	76.1 mm DN65-80	101.6 mm DN100	101.6 mm DN100
A ₁	244	242	242	363
A ₂	193	191	191	316
A ₃	244	244	244	337
A ₄	173	173	173	290
D	85	85	85	133
d	17	17	17	30
l	16.5	16.5	16.5	34
□s	8	10	12	12
Function	NC, NO, A/A	NC, NO, A/A	NC, NO, A/A	NC, NO, A/A

900593

Connections

Compressed air

R¹/₈" (BSP), internal thread.

Seal qualities

EPDM:

The EPDM seal is mechanically strong and normally resistant to ozone and other strong oxidizers, animal and vegetable fats, polar solvents, acids and bases, water and aqueous solutions.

The seal is available in all sizes.

FPM:

Normally resistant to ozone and other oxidizers, hydrocarbons in general, oils, lubricants and greases.

The seal is available in all sizes.

Options

- A. ThinkTop® for control and indication.*
- B. Indication unit with micro switches.*
- C. Indication unit with inductive proximity switches.*
- D. Indication unit with Hall proximity switches.*
- E. Explosion proof indication unit with inductive proximity switches.*
- F. Bracket for actuator.
- G. Handle with two or four positions.
- H. Handle for electrical position indication.
- I. Handle with infinite intermediate positions.
- J. Multipositioning handle**.
- K. Lockable Multiposition Handle. Padlock can be mounted as shown in fig. 5.
Note! Padlock is not delivered.
- L. Special cap for 90° turned handle position.
- M. Service tool for actuator.
- N. Service tool for fitting 25-38 mm (DN25 - DN40) valve discs.

* For further information see Product Catalogue chapter "Control & Indication".

** A padlock can be mounted on the Lockable Multiposition Handle as shown in the opposite figure.

Note! Padlock is not delivered.

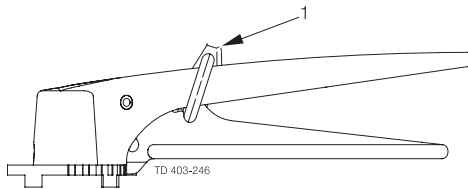

Fig. 3. Lockable Multiposition Handle with padlock.

1. Padlock

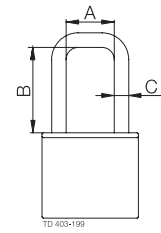

Fig. 4. Dimensions - padlock.

- A. Min. 20 mm
- B. Min. 35 mm
- C. $\varnothing 6$ mm

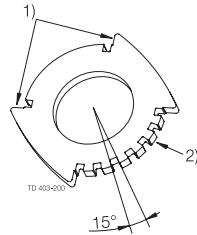

Fig. 5. Positioning cap.

1. On/Off
2. Multi positioning

Ordering

Please state the following when ordering:

- Valve type: Tri-Clover LKB UltraPure
- Valve size
- Connections
- Surface finish
- Rubber grade: EPDM or FPM
- Type of handle, if required

If ordering with actuator:

- Type: LKLA or LKLA-T
- Size: $\varnothing 85$ mm or $\varnothing 133$ mm.
- Function: NC, NO or Air/Air
- Other options

Note!

For further details, see also ESE01699.

ESE01697EN 1007

The information contained herein is correct at the time of issue, but may be subject to change without prior notice.

How to contact Alfa Laval

Contact details for all countries are continually updated on our website. Please visit www.alfalaval.com to access the information direct.

Distributed by:

Tri-Canada

7033 Telford Way #20, Mississauga, ON L5S 1V4
 Tel: 905.677.9000 • Toll Free: 1.800.486.7863
www.tricanada.com